

## INSTRUCTIONS FOR USE

### *Sintering furnace*

# e.ON sinter<sub>base</sub>



Rév. 091120

# e.ON SINTER BASE

A.	EQUIPEMENT DESCRIPTION .....	3
B.	WIRING DIAGRAM .....	4
C.	INSTRUCTIONS FOR USE .....	5
1.	SAFETY INSTRUCTIONS .....	5
1.1.	USE.....	5
1.2.	SAFETY INSTRUCTIONS .....	5
1.3.	WASTE DISPOSAL.....	7
2.	EC DECLARATION OF CONFORMITY.....	7
3.	TECHNICAL INFORMATION .....	8
3.1.	TECHNICAL DATA .....	8
3.2.	CONDITIONS OF USE, TRANSPORT AND STORAGE.....	9
3.3.	ACCESSORIES .....	9
4.	INSTALLATION.....	10
4.1.	UNPACK .....	10
4.2.	INSTALLATION.....	10
4.3.	BEFORE START-UP .....	10
5.	START-UP .....	11
6.	USE AND CONFIGURATION .....	12
6.1.	WORKING INTERFACE.....	12
6.2.	CONTROL KEYS.....	12
6.3.	REAL-TIME CURVE (CURRENT CYCLE).....	12
6.4.	INTERFACE PROGRAM EDITOR .....	13
6.4.1.	CHANGE SETTINGS.....	13
6.4.2.	PROGRAMMING INSTRUCTIONS .....	14
6.4.2.1.	EXAMPLES OF CALCULATION .....	15
6.5.	PARAMETER SETTING .....	15
6.6.	PROGRAMS.....	16
6.6.1.	PROGRAMS PRE-RECORDED: No. 1 and No. 40 (decontamination) .....	16
6.6.2.	EXAMPLE OF PROGRAMS .....	17
6.7.	POSITIONING THE ELEMENTS AND STARTING THE CYCLE .....	18
6.7.1.	POSITIONING OF ELEMENTS AND TRAY FOR SINTERIZING .....	18
6.7.2.	CLOSING THE CHAMBER.....	18
6.7.3.	CLOSING THE PLATFORM AND START CYCLE .....	19
6.8.	EXAMPLE OF CYLCE FOR ZIRCONIA BLOCK IRELAND.....	19
7.	ADVICES - PRECAUTIONS FOR USE .....	20
8.	MAINTENANCE .....	22
8.1.	HEATING ELEMENT REPLACEMENT .....	23
8.2.	TROUBLE-SHOOTING .....	24

*Non-contractual visual*

*Translation into English from original in French*

**A. EQUIPEMENT DESCRIPTION**



No.	DESCRIPTION
1	Door of the chamber
2	Magnetic tablet
3	Touch screen
4	Power switch ON/OFF ( <i>lateral side</i> )
5	Sole ( <i>2 units</i> )
6	Insulating plate
7	Tray for sinterizing cover
8	Tray for sinterizing

**B. WIRING DIAGRAM**

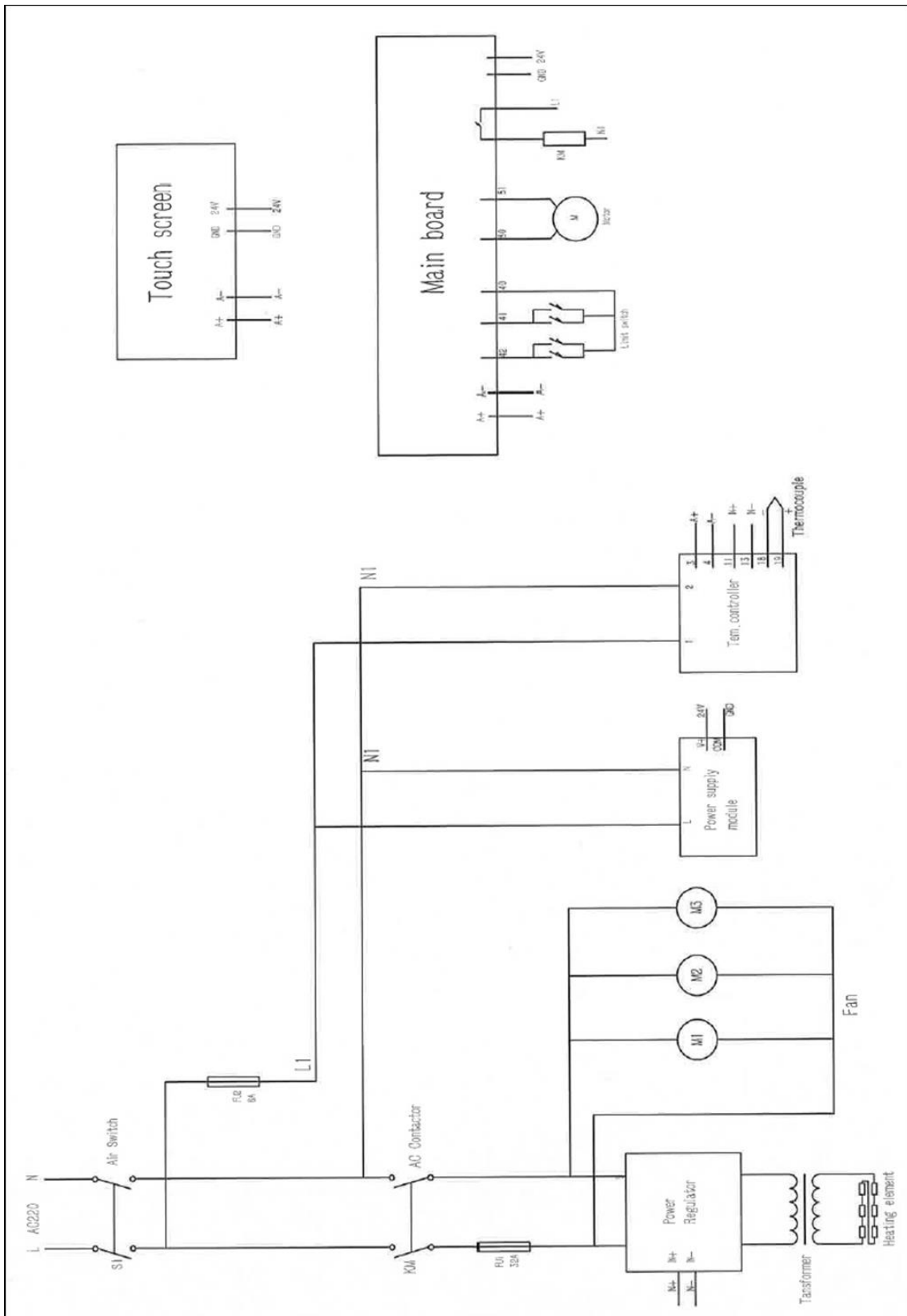

## C. INSTRUCTIONS FOR USE

### 1. SAFETY INSTRUCTIONS

#### 1.1. USE

e.ON SINTER BASE is a sintering furnace to Zirconium oxide (ZrO<sub>2</sub>) dental prostheses. This furnace has to be operated only by dental professionals. e.ON SINTER BASE have to use in the conditions and for the uses described in this manual. Any other use that will be made of it is considered inappropriate. In this case, the manufacturer declines all liability and immediately cancels the equipment warranty.



According to the product’s instructions and functionalities, **it is imperative to read carefully the instructions for use before furnace installation and use.** Retain the manual for future reference.

#### 1.2. SAFETY INSTRUCTIONS

Pictograms’ meaning used in these instructions for use:

	General warning		Electrical hazard		Burn hazard - Hot surface
---	-----------------	---	-------------------	---	---------------------------

Observe following safety instructions:

	<ul style="list-style-type: none"> <li>- During operation and after use, <b>the furnace surface, sole, insulating plate, tray for sinterizing and cover may reach high temperatures: do not touch.</b></li> <li>- Wear suitable gloves for handling prosthetic objects, tray for sinterizing/cover, sole and insulating plate.</li> </ul>
	<ul style="list-style-type: none"> <li>- The unit must be connected to an <b>electrical installation in accordance</b> with the applicable standard in the country in which it is being used. This installation must provide <b>protection against overcurrent, overload and ground faults.</b></li> <li>- <b>This furnace requires its own power line and must be connected to a circuit breaker.</b></li> <li>- <b>Connect it directly to the mains socket.</b> Do not use multiple sockets.</li> <li>- Ensure that the <b>connection cables</b> are in perfect condition to prevent short circuits.</li> <li>- Before any <b>technical intervention</b>, the unit must be switched off (with the breaker) and disconnected from the mains power supply.</li> <li>- <b>Do not spill liquid</b> on the ventilation openings or inside the furnace.</li> </ul>
	<ul style="list-style-type: none"> <li>- <b>Do not place any object inside the chamber</b> (only tray for sinterizing/cover, sole and insulating plate).</li> <li>- The furnace must be placed on a <b>flat surface</b>, keeping sufficient clearance around the unit to <b>ensure proper ventilation.</b></li> <li>- <b>Do not block the ventilation openings</b> to avoid overheating.</li> </ul>



- **For moving:**
  - take hold the furnace by its base: **NEVER LIFT BY UPPER PART OF FURNACE**
  - the furnace must remain in an upright position: **NOT HORIZONTAL POSITION**
- **Never use the furnace without sole and insulating plate.**
- Use only the **sole, insulating plate, tray for sinterizing and cover** provided by UGIN DENTAIRE. Before use, check it (no dirt or damage). **If damage: do not use.**
- **Respect the positioning of elements** (*see chapter 6.7*): damage equipment risk.



- **The chamber is made up refractory ceramic fibres.**
- **Handle carefully.**
- **They can release dust: remove with a vacuum cleaner - do not blow or use compressed air.**



- Use only **genuine spare parts**. The use of non-original spare parts voids any warranty for your device.
- **Do not introduce stranger objects inside** the unit during the maintenance operations. It is forbidden to modify the material without authorization.
- **Do not execute different operations of maintenance** from those brought back in the manual. Whichever operation not included in this manual, can involve risks.
- For whichever information concerning installation, maintenance and use, contact the **customer's service UGIN DENTAIRE.**

### 1.3. WASTE DISPOSAL

Observe the waste disposal regulations for electrical and electronic equipment: do not dispose of with household waste.

The unit is subject to Directive 2012/19/EU on waste electrical and electronic equipment and to the laws of the country in which it is being used, and must be disposed of in accordance with applicable regulations.

The chamber contains refractory ceramic fibres. They must be disposed in accordance with applicable regulations in force.

## 2. EC DECLARATION OF CONFORMITY

The equipment's EC declaration of conformity is provided as appendix of instructions for use.

### Content of the declaration EC:

- Name and address of the manufacturer:  
UGIN DENTAIRE  
25 rue de la Tuilerie  
38170 SEYSSINET-PARISSET – FRANCE
- UGIN DENTAIRE declares, on its own exclusive responsibility, that the product:
  - Sintering furnace **e.ON SINTER BASE**
  - Serial number: *see the equipment's EC declaration of conformity*
- Fulfills the essential requirements of health and safety of the following directives:
  - Machinery directive 2006/42/EC
  - Electromagnetic compatibility directive 2014/30/EU

### 3. TECHNICAL INFORMATION

#### 3.1. TECHNICAL DATA

e.ON SINTER BASE is a sintering furnace to Zirconium oxide dental prostheses. This furnace must be operated only by dental professionals and in the conditions described in this manual (*see chapter 1.1 and 3.2*).

<b>TECHNICAL DATA</b>	
<b>Maximum temperature</b>	1 600°C
<b>Temperature accuracy</b>	± 1°C
<b>Heating rate</b>	To 40°C/minute maximum
<b>Screen</b>	High definition colour touch screen 7" (155x87mm)
<b>Number of programs</b>	40 free programs (with 40 possible stages)
<b>Number of heating elements (rods)</b>	4 in MoSi <sub>2</sub> ( <i>molybdenum disilicide</i> )
<b>Sensor</b>	Sensor double components Pt/Rh ( <i>Platinum / Rhodium</i> )
<b>Dimensions</b> ( <i>height, width, depth</i> )	540mm x 400mm x 450mm
<b>Weight</b>	58 kg
<b>Chamber size</b>	110 mm x 110 mm x 110 mm
<b>Noise level</b>	< 70 dB (A)
<b>Maximum power consumption</b>	1 830 W
<b>Supply voltage</b>	230 V (50/60 Hz)



### 3.2. CONDITIONS OF USE, TRANSPORT AND STORAGE

- **Authorised conditions of use**
  - Ambient temperature: +10°C to +40°C.
  - Humidity range: maximum relative humidity 80% for temperatures until 31°C, without condensation and decrease linear until 50% to 40°C, without condensation.
  - Ambient pressure: up to an altitude of 2000 m above sea level.
- **Authorised conditions of storage**
  - Ambient temperature: -20°C to +65°C.
  - Humidity range: maximum relative humidity 80%.
  - Ambient pressure: up to an altitude of 2000 m above sea level.
- **Conditions to transport**
  - Wait the complete cooling before packing/transporting.
  - Use the original packaging only, with the protective elements (polystyrene...).
  - Take hold the furnace by its base, never lift by upper part of furnace.
  - For transport, the furnace must remain in an upright position: not horizontal position.
  - Install the furnace in the packaging with the protective elements. Also protect the accessories for transportation.



**NEVER LIFT BY UPPER PART OF FURNACE:** risk material damage.  
 For transport, the furnace must remain in an **upright position: NOT HORIZONTAL POSITION.**  
 Heating elements may be damaged in horizontal position due to vibration/shock.

### 3.3. ACCESSORIES

- **Accessories delivered** with the furnace *(included in the packaging)*:

ACCESSORIES	QUANTITY	UGIN CODE
- Tray for sinterizing	1	FCE07SIN0052
- Tray for sinterizing cover	1	FCE07SIN0053
- Box of zirconia pearls	1	FCE03SIN0001
- Sole	2	FCE07THE0005
- Insulating plate	2	FCE07THE0003
- Magnetic tablet	1	---
- Wrench <i>(for tighten the heating elements)</i>	1	---
- Allen wrench <i>(number 3 and 4)</i>	2	---
- Fuse 32A	2	---

## 4. INSTALLATION

### 4.1. UNPACK

- Unpack **e.ON SINTER BASE** and check that it is in perfect order (furnace and accessories).
- Any defects can be reported to the carrier.
- Remember to get the carrier to sign the delivery note.

*NOTE: keep the original packaging to transport the furnace (see chapter 3.2)*

### 4.2. INSTALLATION

- Install in a room aired. Observe the conditions indicated in chapter 3.2.
- Place the furnace on a level and aired surface. Keep a distance from other objects around not less than 25 cm. Keep it away from heat sources (for example, radiators and/or other equipment that release heat).
- Despite excellent insulation, the furnace provides heat and, in the long term, can discolour surfaces that are nearest.
- Do not shake the furnace, avoid vibrations and shock.
- The molybdenum silicon rods are very brittle at room temperature: **DO NOT HANDLE THEM**. Avoid moving the furnace after installation.
- Dust, corrosive or explosive gases can damage the body and the insulation.
- Its forbidden placing inflammables, toxic, volatile or explosives around the furnace.



**This unit requires its own power line and must be connected to a circuit breaker.**

**Grounding is mandatory** to avoid accidents and the dangers of overheating the power line.

Due to the power of furnace: **connect it directly to the mains**, do not use multiple sockets (risk of electrical interference).

### 4.3. BEFORE START-UP

- Open the furnace upper cover (unscrew).
- Carefully remove the cushioning foam pad protecting heating elements.
- **Then visually inspect the heating element** (no damage). Avoid handling.
- Close the furnace cover (screw).

## 5. START-UP

After checking that the mains voltage matches that noted on the rating plate, plug the cord into a standard **20A socket** with a ground terminal.

*NOTE: If not used for a long time, switch off the power supply.*

- a) Activate the breaker (ON/OFF) of furnace.
- b) Following power up, the initialization interface appears on the screen. The main screen automatically appears as follows: **menu "Working interface"**.



- c) Open the door of the heating chamber.  
Remove the protections and dust with a vacuum cleaner or a soft and clean brush (do not use compressed air).



### DO NOT PLACE ANY OBJECT INSIDE THE CHAMBER

*(only tray for sinterizing and cover, sole and insulating plate)*



### IMPORTANT





- **For the first time or after a long time without use, need to preheat the muffle furnace** 1 hour at 120°C follow 2 hours at 300°C to eliminate condensation and avoid fractures of the refractory material.
- **Carry out a decontamination program as a precautionary measure before the first use of the furnace:** start the pre-recorded program number 40 (*see chapter 5.6.1*).

## 6. USE AND CONFIGURATION

### 6.1. WORKING INTERFACE

Following power up, the initialization interface appears on the screen.  
The main screen automatically appears: menu **“Working interface”**.

### 6.2. CONTROL KEYS

PICTURES	KEYS	DESCRIPTION
	<b>Start cycle</b> (RUN)	The selected program is started.
	<b>Pause</b> (PAUSE)	In running state, the program will be in a suspended state, the temperature remains constant.
	<b>Stop</b> (STOP)	Under operating state or suspended state, the program will end.
	<b>Menu</b> (logo Microsoft)	Pull-down menu appears, <u>as shown below</u> :
	<b>Working interface</b>	Parameters current cycle display.
	<b>Real-time curve</b>	Display of the cycle curve (temperature/time).
	<b>Program editor</b>	Program settings.
	<b>Parameter setting</b>	Software settings. Only access with technician code (reserved for technicians customer’s service UGIN DENTAIRE).
	<b>Language selection</b>	Available languages: English, French, Spanish and Italian.
	<b>Date setting</b>	Setting the date, time and day of the week.

### 6.3. REAL-TIME CURVE (CURRENT CYCLE)

This screen shows the diagram of the current cycle (time/temperature).

On the screen are displayed two curves: the temperature setting in the cycle (blue curve) and the temperature in real time (green curve).

The green curve displayed and superimposes the blue curve as the cycle progresses

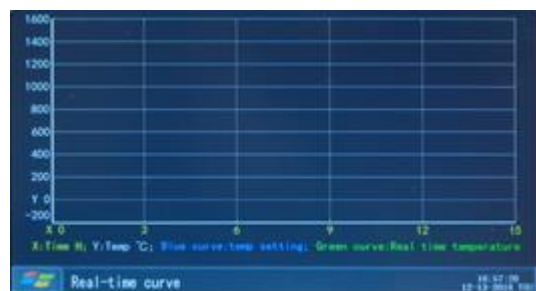

### 6.4. INTERFACE PROGRAM EDITOR

A total of 40 programs, composed of 40 temperature/time pairs, can be edited and saved by selecting a different program number, each program and pairs of can be edited. To select a program, press the right or left arrow key: the numbers of programs is displayed on the screen.

For each program number, the cycle parameters are displayed as a chart:

- C represents temperature (°C), and
- T represents time (minutes).

Each program is two pages: the first page displays the pairs from C01/T01 to C20/T20 and the second page from C21/T21 to C40/T40. The "NEXT PAGE" key switches from the first page to the second page.

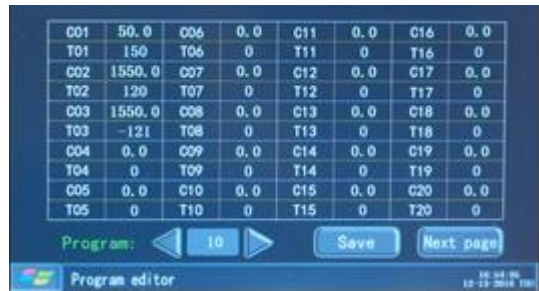

#### 6.4.1. CHANGE SETTINGS

When the program number is displayed on the screen, "press" the parameter to be modified. A numeric keypad is displayed to select the desired value.

Enter the new value using the numeric keypad and press "Ok" to save.

A confirmation message is displayed:

**"Caution: press the Ok key, the data will be saved".**

Press "Ok" to confirm or "Cancel" to cancel.

When the desired changes of program have been made, press "SAVE" key to save the complete program.

After validation, the "Working interface" displayed on the screen.



**6.4.2. PROGRAMMING INSTRUCTIONS**

*C: Temperature in degrees Celsius (°C)*

*T: Time in minutes (min)*

<b>Temperature 1</b>	Used as the <u>temperature start</u> value (usually set to 50).
<b>Time 1</b>	Total duration of first stage (0 to 9999 minutes).
<b>Temperature 2</b>	Final temperature of first stage and start temperature of second stage. Temperature values from C1 to C2 define the <u>increase rate</u> . The value must be <u>less than 10°C/min</u> , when below 300°C.
<b>Time 2</b>	Total duration of second stage (0 to 9999 minutes).
<b>Temperature 3</b>	Final temperature of second stage and start temperature of third stage. If C3 is less than C2 ( <u>temperature decrease</u> ). The value must be <u>less than 30°C/min</u> .
<b>Time 3</b>	Total duration of third stage (0 to 9999 minutes).
<b>Temperature 4</b>	Final temperature of third stage and start temperature of fourth stage. If necessary, the parameters are programmed as for the previous steps.
<b>Last time "-121"</b>	Indicates the end of program, temperature controller works according to the temperature/time parameters setting. When the program detects a "-121", STOP command is activated with return to the previously selected program. "-121" also indicates correct cycle sequence.

**ATTENTION:** The operator must setting the temperature/time initial and the temperature/time final for each stage. These data must be calculated from the desired increase/decrease rate, following the recommendations given (see examples below). Never write on the screen the desired speed directly, the software cannot make the calculation and it takes the value as a temperature or a time "untreated".

 **ATTENTION:** end program with "-121" time, otherwise cycle will not stop.

### 6.4.2.1. EXAMPLES OF CALCULATION

▪ **Calculation time of second stage (T02)**

From the initial and final temperature values of the second stage, calculation of the time stage:

$$\left. \begin{array}{l} \text{Temperature 1} \rightarrow \text{C01} = 900^{\circ}\text{C} \\ \text{Temperature 2} \rightarrow \text{C02} = 1200^{\circ}\text{C} \end{array} \right\} \begin{array}{l} \text{Temperature difference:} \\ \text{C02} - \text{C01} = 1200^{\circ}\text{C} - 900^{\circ}\text{C} = 300^{\circ}\text{C} \end{array}$$

Recommended value of increase rate: less than 10°C/minute  
 300°C at a rate of 10°C/min → 300°C / 10°C = 30 min → **T02 = 30 minutes**

▪ **Parameters for remain to end temperature (T04)**

Parameters temperature/time of end stage to obtain remains to the end temperature of 1520°C for 2 hours:

$$\left. \begin{array}{l} \text{Temperature 4} \rightarrow \text{C04} = 1250^{\circ}\text{C} \\ \text{Temperature 5} \rightarrow \text{C05} = 1250^{\circ}\text{C} \end{array} \right\} \begin{array}{l} \text{Temperature difference} = 0^{\circ}\text{C:} \\ \text{Temperature remains to } 1250^{\circ}\text{C} \end{array}$$
  

$$\left. \begin{array}{l} \text{Time remains: 2 hours} \end{array} \right\} \begin{array}{l} \text{Time 04: 2 hours x 60 min} = 120 \text{ min} \\ \rightarrow \text{T04} = 120 \text{ minutes} \end{array}$$

 Zirconia **SINTERING TEMPERATURES** are given as indicative by disc manufacturer. If necessary, these one **can be adjusted from -15°C to +15°C** around the final temperature recommended. **We recommend adjusting the temperature/time for special work.**

### 6.5. PARAMETER SETTING

This interface requires a password to be accessible.  
**No data may be modified without authorization:** risk of damages on the furnace or trigger heating untimely.  
 The modification of the parameters is therefore **reserved for technicians of customer's service UGIN DENTAIRE.**

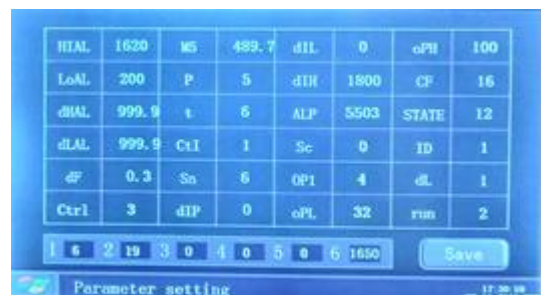

*NOTE: even if changes are made to the settings, when saving them, a screen is displayed to insert the password. When no password has been inserted and validation is done with the "Ok" key, the changes made are not saved and the original settings remain applicable.*

## 6.6. PROGRAMS

### 6.6.1. PROGRAMS PRE-RECORDED: No. 1 and No. 40 (decontamination)

Two programs are pre-recorded in the furnace:

**PROGRAM No. 1**

STAGE	TEMPERATURE (°C)	TIME (min)
1	C1: 50	T1: 25
2	C2: 300	T2: 40
3	C3: 600	T3: 40
4	C4: 1000	T4: 20
5	C5: 1200	T5: 10
6	C6: 1200	T6: 25
7	C7: 1450	T7: 30
8	C8: 1450	T8: 30
9	C9: 1200	T9: 30
10	C10: 1200	T10: -121

**DECONTAMINATION PROGRAM – No. 40**

STAGE	TEMPERATURE (°C)	TIME (min)
1	C1: 50	T1: 40
2	C2: 300	T2: 70
3	C3: 1000	T3: 150
4	C4: 1590	T4: 60
5	C5: 1590	T5: 70
6	C6: 900	T6: -121



**A DECONTAMINATION PROGRAM MUST BE CARRIED OUT AS A PRECAUTIONARY MEASURE BEFORE THE FIRST USE OF THE FURNACE:** start the pre-recorded program number 40.

If use different types of zirconia, zirconia of different brands or zirconia with different sintering temperatures (even during separate sintering cycles) it may be necessary to carry out **regular decontamination of the furnace e.ON SINTER BASE** using the cycle recorded in number 40.

**Decontamination before the 10<sup>th</sup> cycle following the previous one is highly recommended.**

#### PRECAUTIONS:

- **High translucency zirconia are very sensitives.** To avoid and prevent crossed discoloration with other zirconia brand or type, user must do regularly decontamination program.
- If **liquid shades are used** with staining technic, prosthetics units must be dry and preheated with an infra red lamp or into an oven to prevent pollution into the eON SINTER BASE, in following zirconia and shades manufacturer recommendations.
- **White clusters can appear on the rods** (heating elements) when different brands or types of zirconia are used. In this case user must clean muffle and rods with a special zirconia cleaner like Nacera Clean (registered brand) with decontamination program No. 40.
- **Always place the sole (2 units) and insulating plate in the chamber** during carry out a decontamination cycle.

**ADVICE: add white Zirconia smashed in multiple small pieces** (absorption of pollutants) **to improve the effectiveness of decontamination:**

- yellow colour = enclosure still contaminated: repeat a decontamination cycle



- black colour = ok: furnace ready

**6.6.2. EXAMPLE OF PROGRAMS**

Next, and as an example, four sintering curves:

**SINTERING CURVE No. 1**

*(1 to 3 unit or bridges)*

<b>Stage</b>	<b>Temperature (°C)</b>	<b>Time (min)</b>
1	C1: 0	T1: 30
2	C2: 300	T2: 30
3	C3: 1000	T3: 120
4	C4: 1480	T4: 60
5	C5: 1480	T5: 60
6	C6: 800	T6: -121

**SINTERING CURVE No. 2**

*(4 to 5 unit or bridges)*

<b>Palier</b>	<b>Temperature (°C)</b>	<b>Time (min)</b>
1	C1: 0	T1: 30
2	C2: 300	T2: 60
3	C3: 1000	T3: 180
4	C4: 1480	T4: 90
5	C5: 1480	T5: 60
6	C6: 800	T6: -121

**SINTERING CURVE No. 3**

*(6 to 8 unit or bridges)*

<b>Stage</b>	<b>Temperature (°C)</b>	<b>Time (min)</b>
1	C1: 0	T1: 30
2	C2: 300	T2: 60
3	C3: 1000	T3: 240
4	C4: 1480	T4: 90
5	C5: 1480	T5: 90
6	C6: 800	T6: -121

**SINTERING CURVE No. 4**

*(9 and above unit or bridges)*

<b>Stage</b>	<b>Temperature (°C)</b>	<b>Time (min)</b>
1	C1: 0	T1: 30
2	C2: 300	T2: 90
3	C3: 1000	T3: 360
4	C4: 1480	T4: 90
5	C5: 1480	T5: 90
6	C6: 800	T6: -121

## 6.7. POSITIONING THE ELEMENTS AND STARTING THE CYCLE

### **IMPORTANT!**

Before use, check if it is in perfect condition the tray, cover, sole and insulating plate: presence of dirt or damage.



- Clean with brush if necessary (see chapter 8 - Maintenance)
- If the component is damaged or cracked, do not use and replace it.

Use only the original tray, cover, sole and insulating plate e.ON SINTER UGIN DENTAIRE

### 6.7.1. POSITIONING OF ELEMENTS AND TRAY FOR SINTERIZING

- Empty a zirconia pearls into a tray (a layer at the bottom to prevent the elements from rubbing on the bottom and sides).
- Place the elements in a tray (avoid touch amongst themselves).
- Always place the cover on the tray.
  - Capacity till 20 units.
  - Beads for sinterizing must be changed in any tray if a discoloration in yellow colour appears.

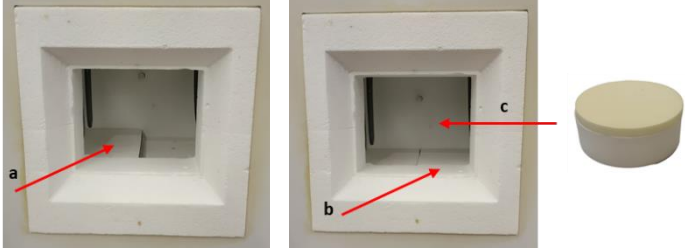
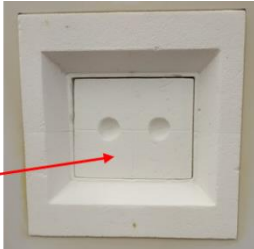
### 6.7.2. CLOSING THE CHAMBER

<p><b>1</b></p>  <p><b>Check if the heating chamber</b> is in perfect condition: presence of dirt or damage, any object.</p>	<p><b>2</b></p>  <ul style="list-style-type: none"> <li>- Place the <b>sole</b> in the chamber (both units: a &amp; b)</li> <li>- Place the <b>tray for sinterizing</b> (see chapter 6.7.1) at the center of chamber (c)</li> </ul>
<p><b>3</b></p>  <p>Place the <b>insulating plate</b> (vertically) for closing the chamber.</p>	<p><b>4</b></p>  <p><b>Close the door</b> of the chamber.</p>

Note: the sole can remain at its location for the realization of the following cycles.

**At the end of the cycle, wear suitable gloves** to remove insulating plate and tray for sinterizing: hot surfaces - risk of burns.

### 6.7.3. CLOSING THE PLATFORM AND START CYCLE

When the cycle has been selected and setting (*see previous chapters*) start the cycle: press “RUN” key.

*Note: when start the cycle, a noise can be generated by the power transformer.*

### 6.8. EXAMPLE OF CYLCE FOR ZIRCONIA BLOCK IRELAND



**EXAMPLE CYCLE: ZIRCONIA BLOCK IRELAND**

SEQEUNCE OF CYCLE	Sintering curve		
	Stage	Temperature (°C)	Time (min)
1. 10°C/min, time required: 30 minutes	1	C1: 0	T1: 30
2. 17,5°C/min, time required: 40 minutes	2	C2: 300	T2: 40
3. 4,83°C/min, time required: 100 minutes	3	C3: 1000	T3: 100
4. Remains: time required 120 minutes	4	C4: 1480	T4: 120
5. Cooling 13°C/min, time required: 52 minutes	5	C5: 1480	T5: 52
6. Natural cooling	6	C6: 800	T6: -121

- Total programmed time: 342 minutes (5h 42min)
- Natural cooling time: 268 minutes (4h 28min)
- Total cycle time: 610 minutes (10h 10min)

## 7. ADVICES - PRECAUTIONS FOR USE

### GENERAL

---

- During operation and after use, the surface of **the furnace head may become very hot: avoid direct contact** with the skin (*risk of burns*).
- eON SINTER BASE is equipped with **heat extractors** to control the temperature of the components and guarantee safety: **do not cover the furnace during use** and **do not place objects** on the furnace or on the ventilation openings.

### CYCLE START AND CONFIGURATION

---

- **Do not open the door during high temperature cycles:** danger of burns and risk of irreversible damage to heating elements and refractories.
- At the end of the cycle, **the temperature must be lower than 300°C before opening the furnace. Do not switch off the power supply**, because heat extractors are stopped and the internal temperature increases and can damage the equipment.
- If the **temperature is above 300°C, it is not possible to start a cycle** (risk of damaging the refractories.) Wait for cooling: temperature displayed on the screen below 300°C.
- When the **temperature is below 200°C, the power supply can be switched off** (switch at the back of furnace).
- At the end of the cycle, the furnace automatically returns to the **standby position**.
- When the **furnace is in standby, the door must be closed** to avoid condensation.
- **At the start of the cycle, avoid using an increase rate too fast** to avoid damaging the heating elements. Likewise, **a large difference between two increase rates is not recommended**.
- **Observe the recommendations of the manufacturer of Zirconia** to avoid significant gaseous emissions which may damage the muffle.
- For the first time or after a long time without use, need to **preheat the muffle furnace 1 hour at 120°C follow 2 hours at 300°C** to eliminate condensation and avoid fractures of the refractory material.
- Zirconia sintering temperatures are given as indicative by disc manufacturer. **If necessary, these one can be adjusted from -15°C to +15°C around the final temperature recommended**.

### HEATING ELEMENTS (RODS)

---

- Molybdenum silicon rods are very brittle at room temperature: **do not handle them**.
- The **heating elements must not be maintained for long periods between 400°C and 700°C** to avoid their oxidation.

**ELEMENTS - CHAMBER** (see chapter 6.7.1 – 6.7.2)

- 
- **Place the sole (2 units) and insulating plate** while the furnace is working.
  - **Always place the elements in the tray for sinterizing, with the zirconia beads inside, and place the cover.**
  - Observe the information about the positioning of elements (chapter 6.7).
  - Beads for sintering must be changed in any tray if a **discoloration in yellow colour** appears.

**DECONTAMINATION PROGRAM** (see chapter 6.6.1)

- 
- **Before first sintering, user must launch a decontamination program (No. 40).**
  - **Always place the sole (2 units) and the insulating plate in the chamber during carry out a decontamination program.**
  - Add white Zirconia smashed in multiple small pieces (absorption of pollutants) to improve the **effectiveness of decontamination**:
    - yellow colour = enclosure still contaminated: repeat a decontamination cycle.
    - black colour = ok: furnace ready.
  - **High translucency zirconia** are very sensitives (crossed discoloration risk): user must do regularly decontamination program.
  - If **liquid shades** are used with staining technic, prosthetics units must be dry and preheated with an infra-red lamp or into an oven to prevent pollution into the **eON SINTER BASE**, in following zirconia and shades manufacturer recommendations.
  - **White clusters can appear on the rods** (heating elements) when different brands or types of zirconia are used: user must clean chamber and rods with a special zirconia cleaner like *Nacera Clean (registered brand)* with decontamination program.

*Note: observe the instructions set out in chapter 8 – maintenance.*

## 8. MAINTENANCE



**Before to carry out the maintenance work and/or cleaning:**



- **disconnected from the main power supply** (*switch OFF and unplug to mains socket*),
- **at room temperature: wait the cooling after use** (*risk of burns and/or damage*).

Observe the following recommendations to ensure the longevity of the device:

- Do not use abrasive, solvents or flammables products for cleaning (outside and inside).
- Clean the machine outside with a soft, dry cloth.
- Remove any traces on the **screen** with a soft cloth and a small amount of special glass cleaner. Cleaning wipes for optic products can also be used. For avoid screen damage, do not use a sharp object to operate the touchscreen.
- In case of dust into the **chamber**: remove it with a vacuum cleaner – do not used compressed air.
- **Visual inspection of the sole, insulating plate and the tray/cover** before use.  
If necessary, clean with a vacuum cleaner to remove any particles (dust) - do not use compressed air.  
If the support is damaged or cracked: do not use and replace-it.
- Clean regularly the chamber with a vacuum cleaner (no compressed air).
- The sole can remain at its location for the realization of the following cycles. Regularly, remove it and clean both elements and the chamber with a vacuum cleaner (no compressed air).
- Regularly check the **electrical contacts** of the heating elements and tighten.

*NOTE: do not use compressed air to cleaning: risk of damage to the accessories and the suspension of particles of the refractory material.*

### 8.1. HEATING ELEMENT REPLACEMENT

Observe these conditions for replacing heating elements:

- preferably, be at room temperature (+15°C/+25°C): the heating elements are very sensitive to temperature;
- handle them carefully;
- keep all elements of heating elements: heating elements and cushioning foam pad protecting.



▪ **Steps to heating element replacement**

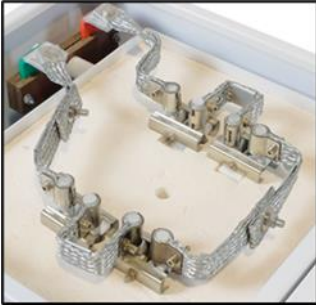

**1. Open the furnace upper cover** (unscrew).



**3.** Repeat step 2 for all the heating elements to replace.

**7. Reassemble in the reverse order.**



**2. Unscrew the electrical contacts** of heating elements with a wrench (*supplied as an accessory*).



**4. Unscrew the support elements** of heating element with a wrench (*supplied as an accessory*).

**5. Remove carefully the cushioning foam pad** protecting heating elements.  
**Lift carefully** the heating element with the elements protecting.

**6. Place the new heating element.**  
The heating element (black section) must be positioned 5mm above the insulating ceramic blocks.  
**CAUTION:** the ends of the heating elements must be separate from the top cover of the furnace to avoid deformation.

*NOTE: these operations are **only for damaged heating element to replace.***

## 8.2. TROUBLE-SHOOTING

<i>Problem</i>	<i>Cause</i>	<i>Procedure to followed</i>
<b>The 1818.3 temperature is displayed on the touch screen</b>	Defective thermocouple, (broken or not properly connected)	<ul style="list-style-type: none"> <li>- Do not use the furnace: risk of material damage.</li> <li>- Turn off furnace (<i>switch ON/OFF</i>).</li> <li>- Contact the after-sale service.</li> </ul>
<b>The result is not satisfactory</b>	The parameters of the program performed (temperature/time) are not adequate	<ul style="list-style-type: none"> <li>- Check the program parameters: temperature and time.</li> <li>- Adjust sintering temperatures if necessary. (<i>see chapter 6.4</i>)</li> </ul>
<b>The furnace does not heat up</b>	It is necessary to test the continuity of the rods	<ul style="list-style-type: none"> <li>- Do not use the furnace: risk of material damage.</li> <li>- Turn off furnace (switch ON/OFF).</li> <li>- Contact the after-sale service for assistance in the procedure.</li> </ul>
<b>White clusters visible on the rods</b>	Due to the use of different brands or types zirconia	<ul style="list-style-type: none"> <li>- <b>Clean the chamber</b> using a <i>Nacera Clean</i> type product (registered trademark) and launch a <b>decontamination program</b> (pre-recorded in No. 40).</li> </ul>
<b>Zirconia pearls have a discoloration in yellow colour</b>	Pearls are polluted	<ul style="list-style-type: none"> <li>- <b>Replace</b> with new sintering beads.</li> </ul>





25 rue de la Tuilerie · 38170 Seyssinet-Pariset · FRANCE  
**Tél. : (+33) 4 76 84 45 45** · [info@ugin-dentaire.fr](mailto:info@ugin-dentaire.fr) · [export@ugin-dentaire.fr](mailto:export@ugin-dentaire.fr)

SAS au capital de 180 000 € - GRENOBLE B 390 633 451 00070 - APE : 2821Z - NIF : FR41 309633451 - N° EORI : FR30963345100070

[ugindentaire.fr](http://ugindentaire.fr)  